

# Dynamotion PROFILE



**DYNAMOTION**

move your engineering



UNIVERSITÀ  
DEGLI STUDI  
DI PADOVA



DEPARTMENT OF  
INDUSTRIAL ENGINEERING

2010

Dynamotion is founded as a spin-off of University of Padova

2017

Company revision, new services dedicated to the manufacturing industries

2023

Launching the new laboratory facility

...

Growing with the aim of covering more industrial segments



## COMPANY

We support companies in developing cutting-edge products and enhancing their development capabilities.

Dynamotion is at the side of companies that face dynamic and kinematic problems in their product development process.

### Area



Motorcycle & Bicycles



Robotis



Automotive



Racing



Sports Goods

[www.dynamotion.it](http://www.dynamotion.it) - [info@dynamotion.it](mailto:info@dynamotion.it)



**2-wheeled vehicles**



**Trasformers**



**Food and Beverage**



**Health Care**

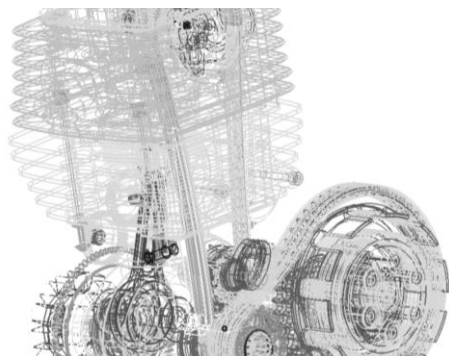

**Combustion engines**

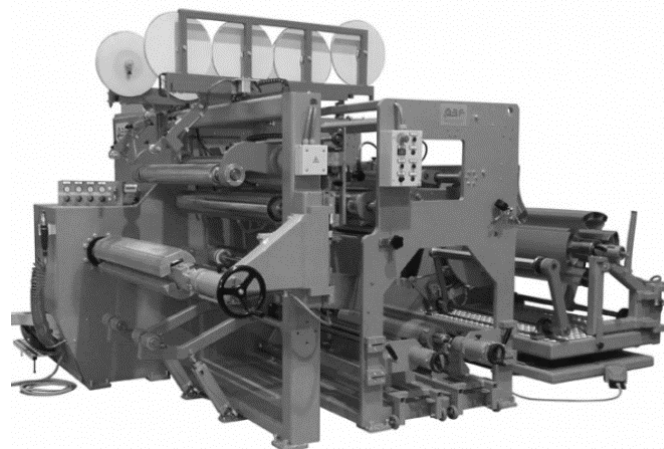

**Industrial machines**

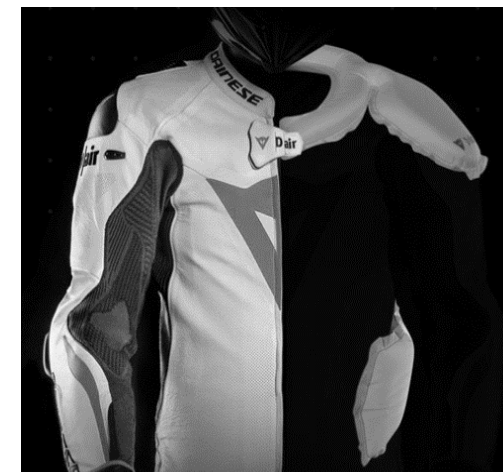

**Sport and Safety**

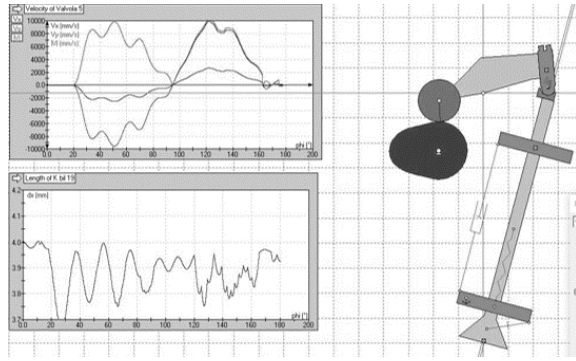

## Simulations

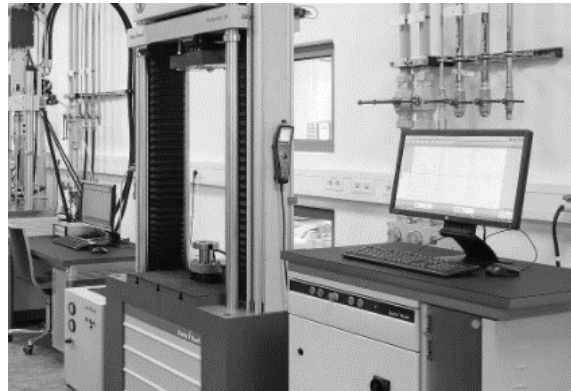

## Lab Testing

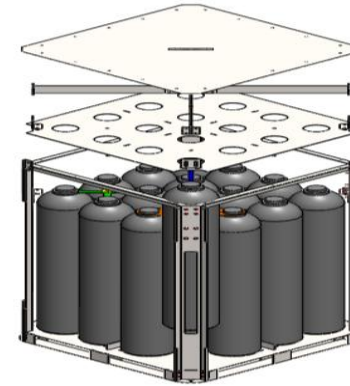

## 3D Modeling

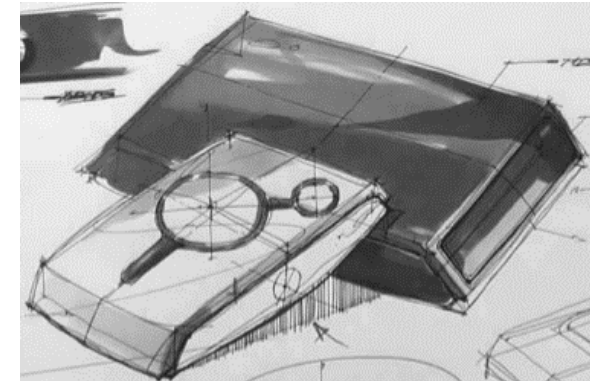

## Industrial design



## Outdoor / On Site Testing

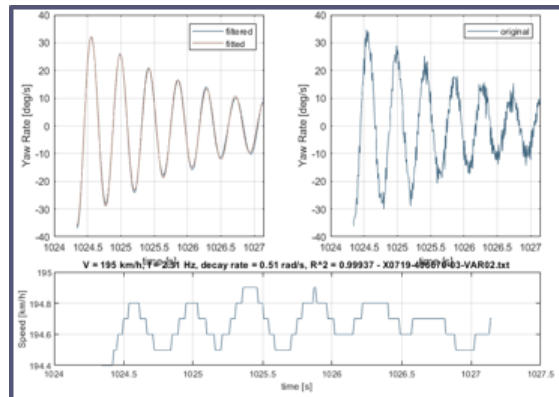

## Data Analysis

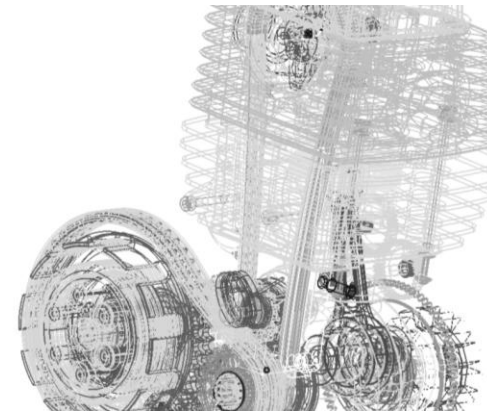

## Prototypes

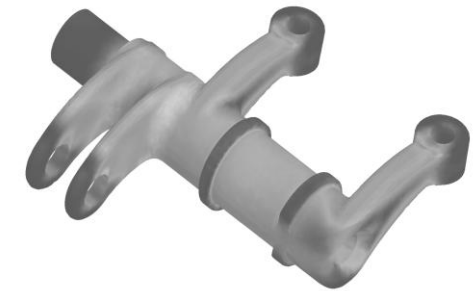

## Structural Analysis



Airbag Racing



Speed Record

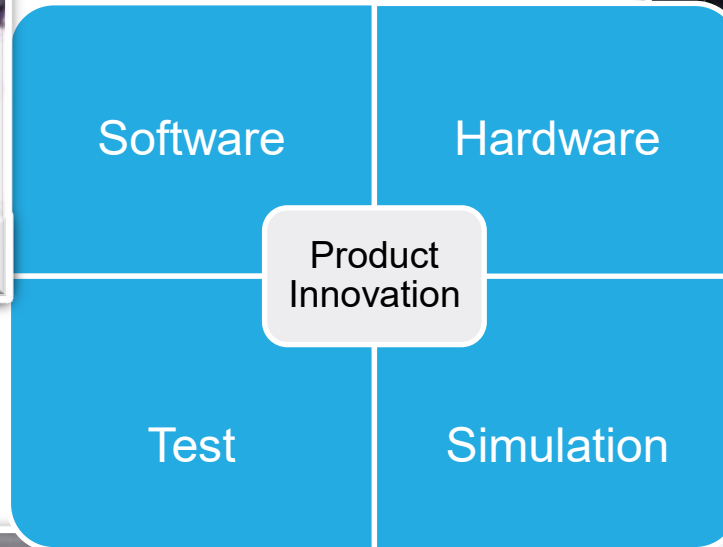

Suspensions



Formula One

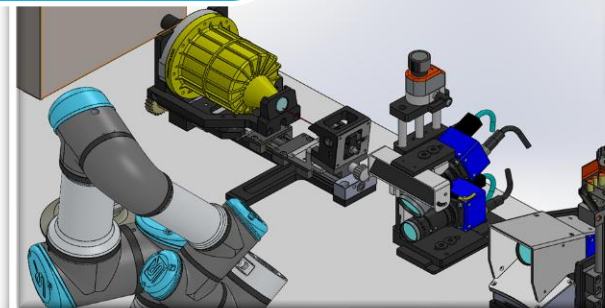

Automation and control



World Superbike